

Agilent 89600 Series Vector Signal Analyzers

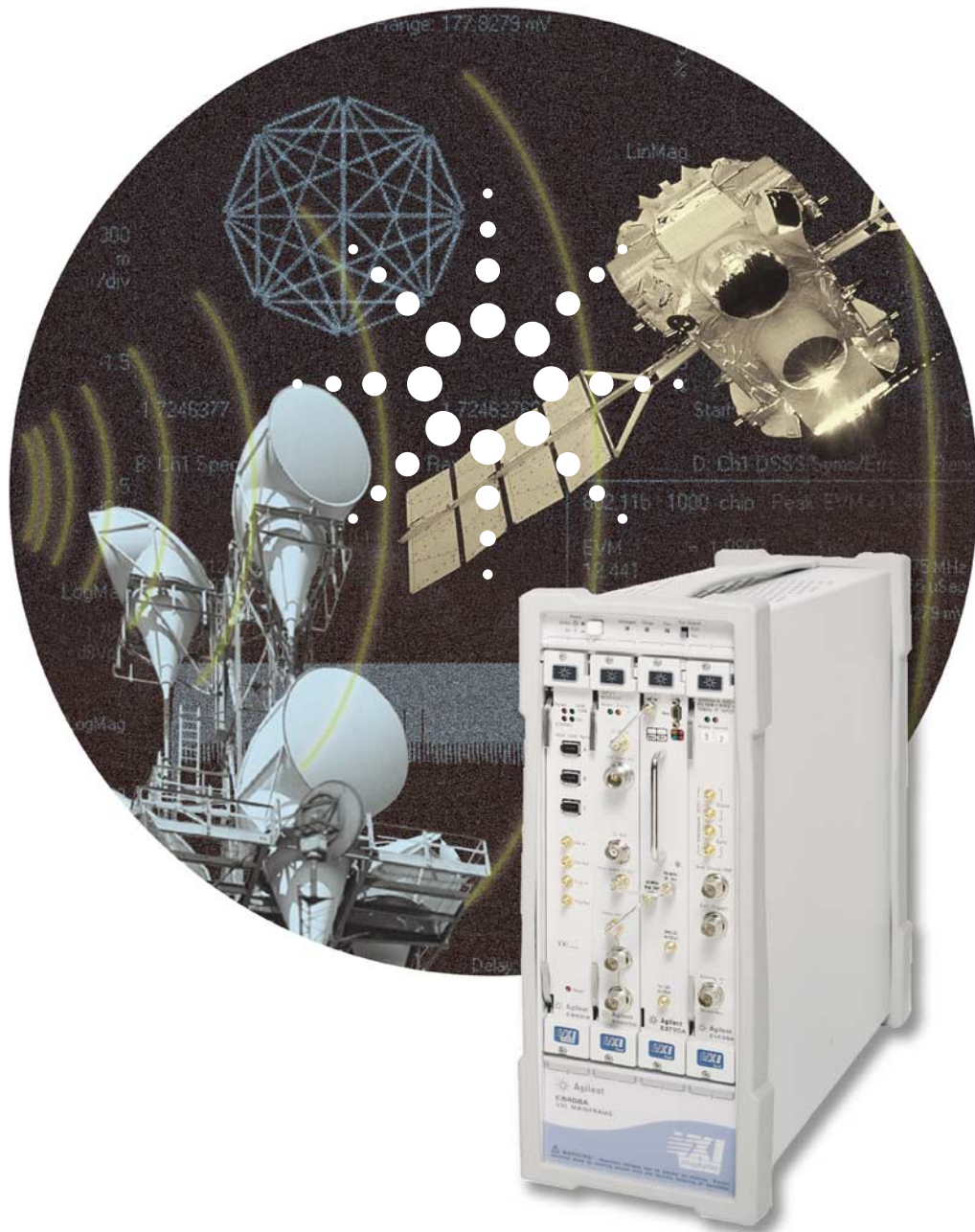

- Up to 6.0 GHz frequency range
- 36 MHz bandwidth (39 MHz in baseband)
- Wireless comms, wireless LAN, satellite, and broadband access

Troubleshoot RF and DSP Problems

The Agilent Technologies 89600 Series vector signal analyzer (VSA) facilitates faster and easier communication system design from initial design simulation to final hardware prototype. It offers 36 MHz bandwidth capacity for measuring signals such as cellular and satellite communications, digital video, wireless LAN (WLAN), and local multipoint distribution service (LMDS).

Spectrum analyzers with demodulation capability are useful tools for highlighting an existing problem. However, many DSP or RF problems can create high adjacent channel power or poorly locked constellations. With the 89600 VSA's sophisticated and unique error analysis tools, you can actually determine the root causes of the problems.

The 89600 Series VSA dynamically links to Agilent's Advanced Design System (ADS), electronic design automation software. This tight linkage means you can use the 89600 to evaluate simulated data and measurement results from hardware – providing you confidence in results because the same measurement algorithms are used during simulation and test.

Links to the Agilent ESG signal generators from both the ADS software and the 89600 VSA mean you no longer need to wait for all of the hardware stages in a block diagram to come back from fabrication to look for system level problems.

In combination with the ESG, the 89600 VSA can uncover RF and DSP problems throughout the radio block diagram – even before hardware exists.

Working with hard-to-measure signals – bursted, hopped, modulated – is a fact of life for designers of today's high-performance communications systems. When creating a new design, it takes time to find the causes of system problems. The Agilent 89600 Series VSAs combine time-, frequency- and modulation-domain analysis to provide measurements and displays that help you look in the right place sooner.

More than a spectrum analyzer

The 89600 VSAs provide traditional spectrum displays and measurements, but today a spectrum analyzer isn't enough. New digital formats require new measurements. Familiar tools such as spectrum analyzers with demodulation may indicate that a problem exists, but they can't help you understand the cause of the problem. For instance, incorrect filtering, spurious interference, incorrect interpolation, DAC overflow, symbol mistiming and other errors may all increase adjacent channel power and distort the constellation. The 89600 Series VSA can identify which of these is the root cause of the problem.

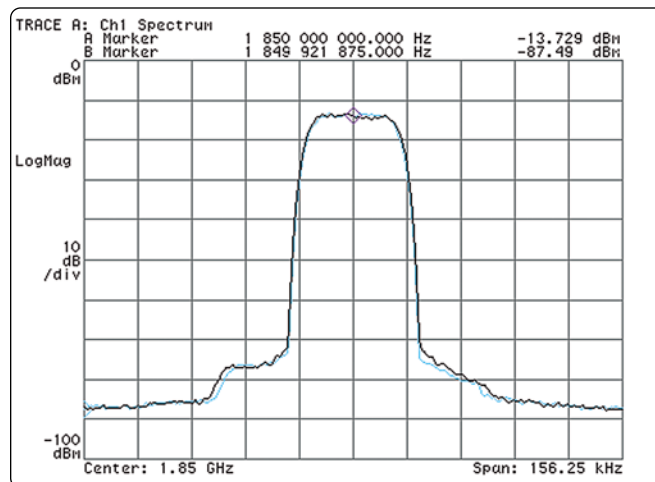

These two signals appear almost identical when viewed with a spectrum analyzer. However, this radio will not transmit a bit. The second signal is off in its center frequency, symbol clock rate, and filter alpha. Spectrum analyzers with demodulation will all show high ACPR and a cloudy constellation, but only a 89600 VSA can identify these problems with a single screen using its EVM versus time display.

The Architecture For a New Breed of Signals

The 89600 VSAs possess an architecture similar to your own digital radio; they rely on DSP for most of their analysis, for example fast fourier transforms (FFT) for spectrum display and DSP algorithms for optional demodulation. Signals are digitized with careful attention to both magnitude and phase. Once digitized, the signals are available for manipulation by the built-in measurement and analysis capabilities of the 89600, or available for storage and eventual analysis by external means.

The 89600 provides many measurement displays for analyzing continually changing phase, magnitude, and frequency. Some displays, like the constellation and vector diagrams, are familiar to radio designers. Others, like the spectrogram display are tools for qualitatively understanding system behavior.

The 89600 relies on a PC for its processing. Improvements in PC capabilities automatically improve the analyzer's performance.

New capabilities for integrating test instrumentation and design automation software are also made possible because the VSA can analyze data from its own hardware or time series data from computational tools.

The VSA architecture resembles a generalized digital radio. DSP demodulation algorithms with user-controlled modulation parameters provide flexible demodulation for a range of new and emerging formats, including 3G and WLAN.

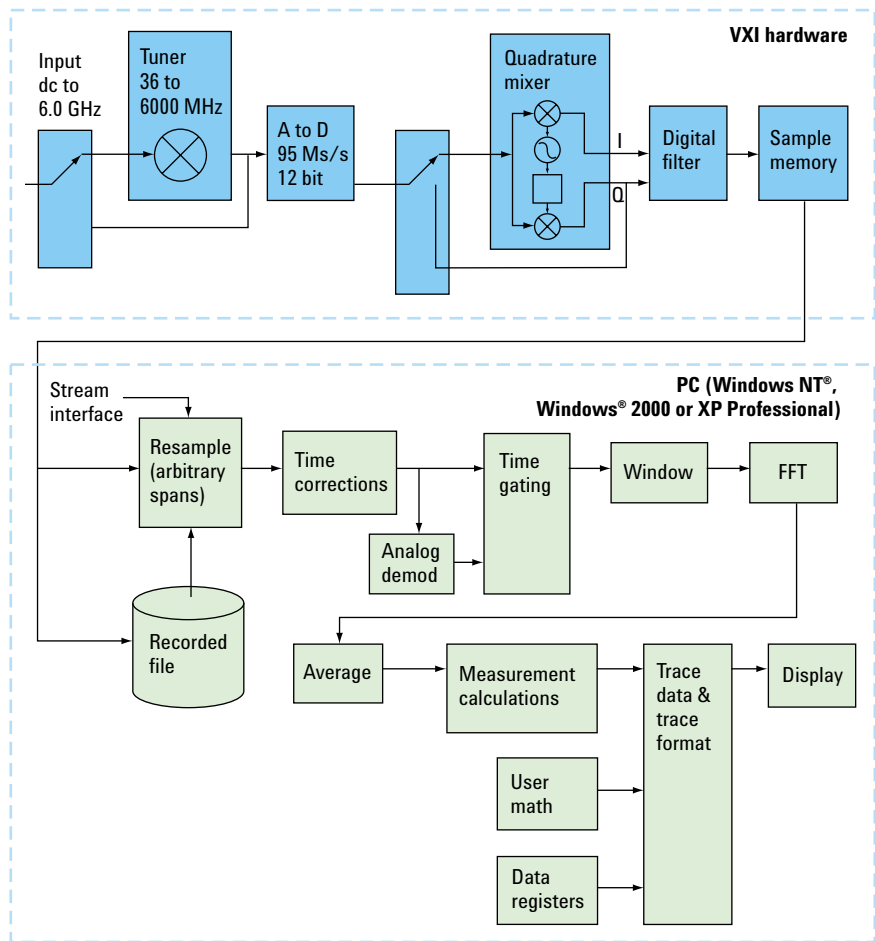

The Measurement Performance to Get The Job Done

The 89600 uses VXI measurement hardware and is connected to the PC through an IEEE 1394 bus for maximum data transfer speed. All digital signal processing is done in the PC (Windows, 2000 or XP Professional), giving you the advantage of linking to other applications like Agilent's ADS and MATLAB®. The Agilent 89600 Series VSAs can be programmed using COM API Active X programming.

89610 baseband VSA (dc to 40 MHz)

Outstanding baseband performance

The 89610 is a single-channel baseband VSA with a 39 MHz maximum analysis bandwidth and excellent phase noise, sensitivity, and amplitude accuracy. The 89610 has a 100 Msa/s analog-to-digital converter with optional 768 Msa (1152 MB) signal capture memory.

A second channel can be added to the 89610 providing an overall bandwidth of 78 MHz (I + jQ mode).

89611 70 MHz IF VSA (52 to 88 MHz)

Great IF performance

Use your own tuner with this high-performance VSA. The Agilent 89611 IF VSA works with any 70 MHz IF center frequency tuner for IF bandwidths up to 36 MHz. With a 95 Msa/s digitizer and optional 768 Msa signal capture memory you can easily analyze complex, time-varying signals. The 89611 also has excellent phase noise, sensitivity and amplitude accuracy.

Key 89600 specifications

	89610	89640	89611 ¹	89641
Frequency range	dc to 40 MHz	dc to 2.7 GHz	52 to 88 MHz	dc to 6 GHz
Amplitude accuracy	±0.8 dB	±2.0 dB	±0.8 dB	±2.0 dB
Spurious response	< -70 dB	< -65 dB	< -70 dB	< -65 dB
Sensitivity	< -152 dBm/Hz	< -158 dBm/Hz	-157 dBm/Hz	< -154 dBm/Hz

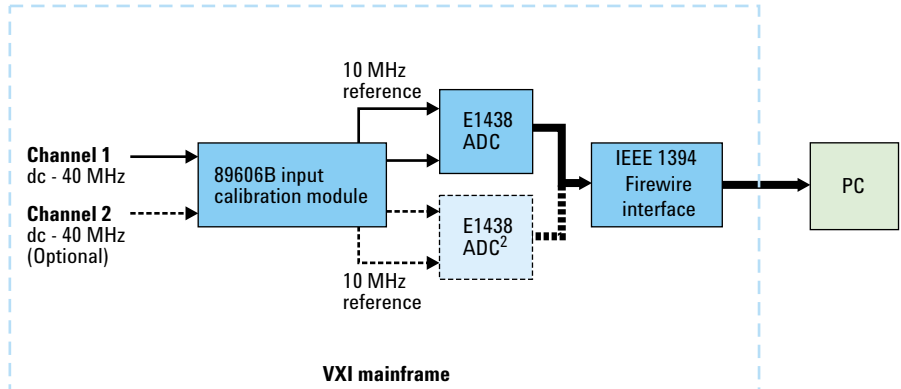

89610 vector signal analyzer system

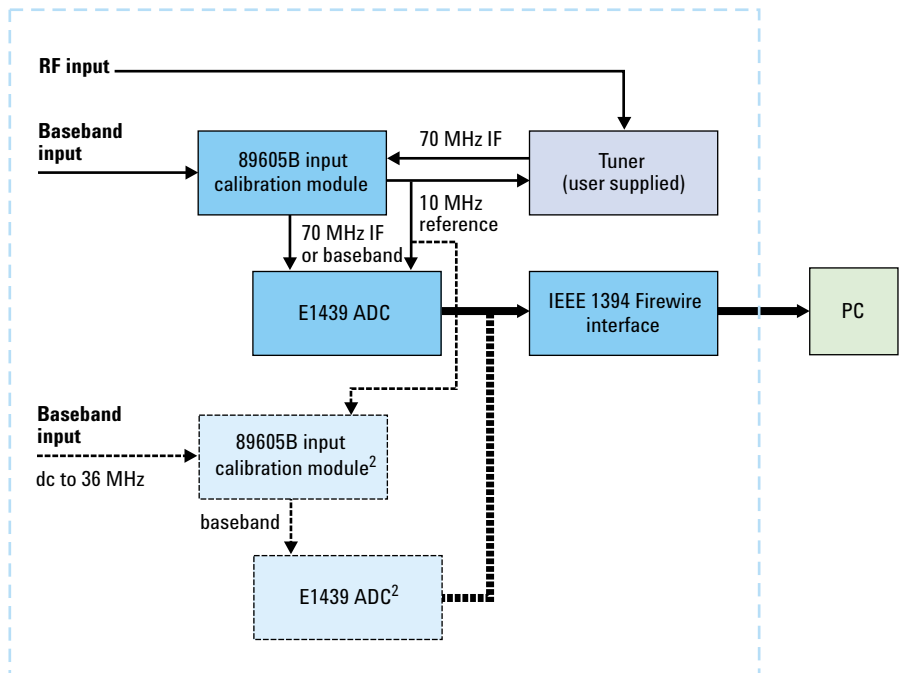

89611 IF vector signal analyzer system

1. Specifications without a tuner.
2. Optional second baseband channel.

89640 RF VSA (dc to 2.7 GHz)

Excellent RF performance

To meet the needs of most wideband development requirements, the Agilent 89640 VSA offers a very wide analysis bandwidth of 36 MHz. The same 95 Msa/s digitizer and optional 768 Msa signal capture memory found in the 89611 are also in the 89640 so you can handle wideband complex, time-varying signals.

89641 RF VSA (dc to 6.0 GHz)

Extended RF performance

Analyze and troubleshoot digital communications signals, WLAN signals and more with Agilent's 89641 6.0 GHz VSA. As with the 89640, the 89641 offers 36 MHz of analysis bandwidth, enough to analyze even double-bandwidth "turbo" mode WLAN chips. Combine this bandwidth with the excellent phase noise, sensitivity and amplitude accuracy of the 89641 and you have an exceptional tool for analyzing time-varying signals ranging from 802.11a to GSM and NADC.

Ground breaking two RF channel capability

Now you can measure relative phase by adding a second RF channel to either an 89640 or an 89641. The tuners in each channel share local oscillators and the ADC's run on the same sample clock making phase measurements between the two channels possible up to 2.7 GHz. Use the two channels to measure phase between antennas in a phased array or smart antenna design, make cross-spectrum measurements, or read stimulus and response signals simultaneously to speed MCPA distortion testing. All of this and more is available with the two RF channel capability.

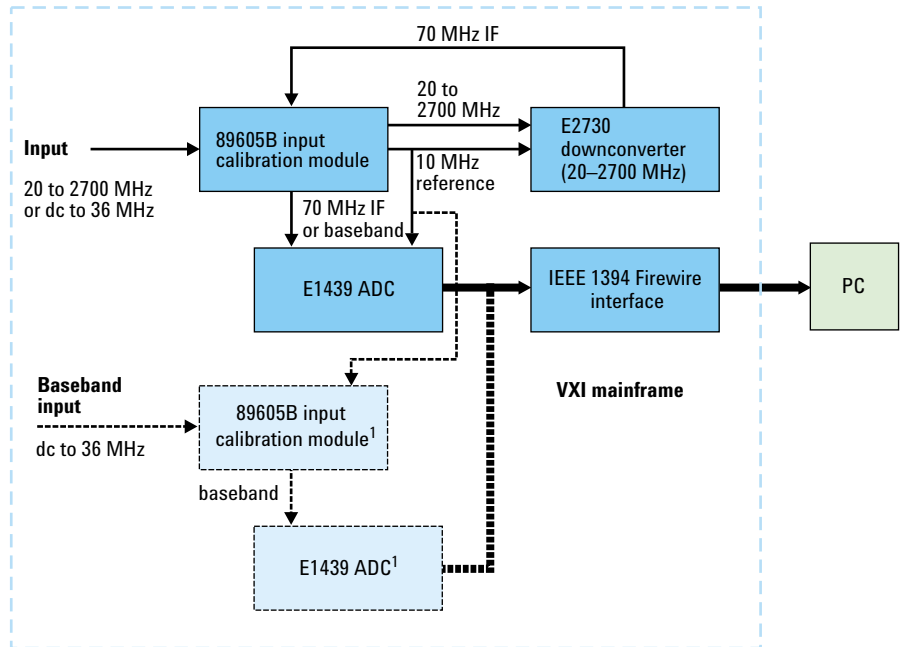

89640 vector signal analyzer system

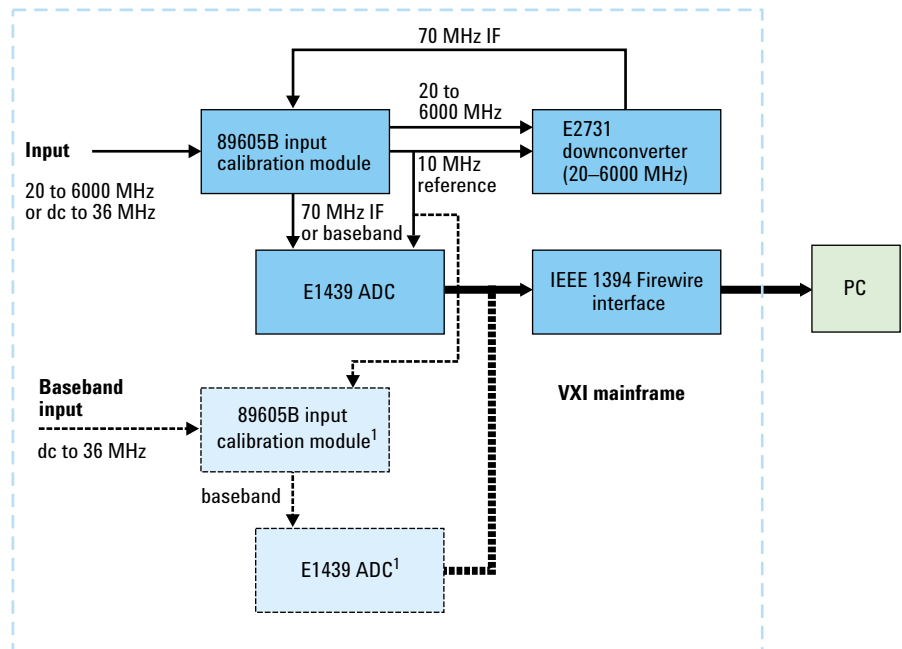

89641 vector signal analyzer system

1. Optional second baseband channel.

Powerful Vector Modulation Analysis (Option AYA)

The real power of a VSA is its ability to analyze complex, time-varying signals. The 89600 VSA analyzes a wide variety of standard formats, including the enhanced data rates for GSM evolution (EDGE), and cdmaOne, as well as other generally used modulation formats.

You can quickly evaluate and troubleshoot digitally modulated signals with both qualitative displays and quantitative measurements. Then, visualize system performance rapidly and intuitively with familiar display formats.

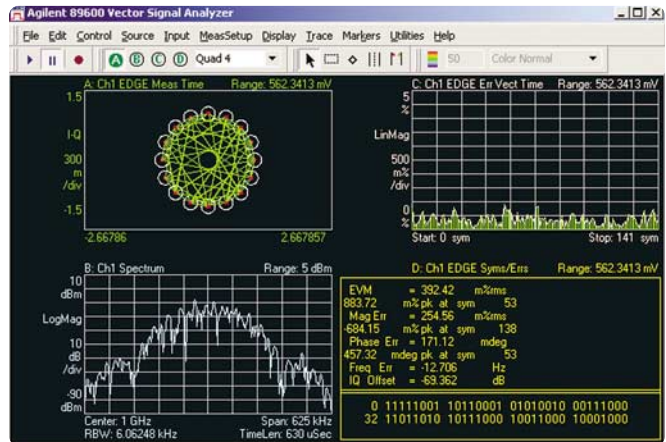

This EDGE constellation uses an innovative ISI compensation filter to provide a legible constellation display without compromising the integrity of the signal itself.

Supported modulation formats

Available with Option AYA

APCO 25	Bluetooth™
CDMA Base	CDMA Mobile
CDPD	DECT
DTV8	DTV16
DVB16	DVB32
DVB64	EDGE
GSM	HIPERLAN/1 (HBR)
HIPERLAN/1 (LBR)	NADC
PDC	PHP (PHS)
TETRA	WLAN (802.11b)
	VDL mode 3

Available with Option B7N

W-CDMA (3GPP); cdma2000 (3GPP2); TD-SCDMA; 1xEV-DO

Available with Option B7R

WLAN (802.11a, b, g); WLAN (HIPERLAN/2)

General modulation formats

(with variable center frequency, symbol rate, filtering type and alpha/BT)

BPSK, 8PSK	FSK 2-, 4-, 8-, 16-level
QPSK	DQPSK
Pi/4 DQPSK	D8PSK
MSK type 1, type 2	Offset QPSK
QAM 16-, 32-, 64-, 128-, 256-	EDGE
VSB 8-, 16-	DVBQAM 16, 32, 64

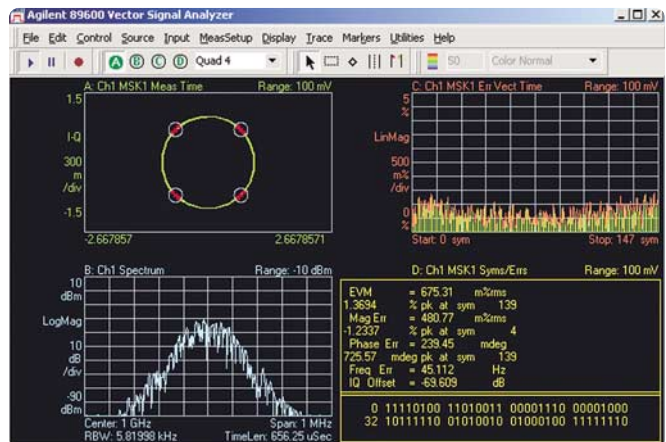

GSM signal MSK format with spectrum and EVM versus time.

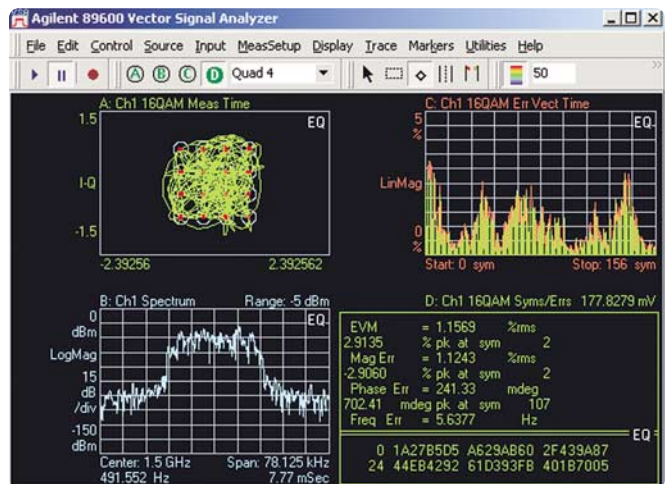

16QAM signal with spectrum and error vector magnitude versus time display.

Effective 3G Format Analysis (Option B7N)

Evaluate and troubleshoot 3G modulation formats such as W-CDMA and cdma2000 with Option B7N, 3G modulation analysis. Both forward and reverse links are supported.

View composite measurements of the code domain power (CDP), time, spectrum, phase and magnitude code error. Or view these for an individual channel. In addition, a new code domain error measurement provides a histogram of error vector magnitude (EVM) versus channel.

TD-SCDMA

Troubleshoot and analyze your time division synchronous code domain multiple access (TD-SCDMA) modulation and RF performance with the enhanced 3G option (B7N) to Agilent's 89600 Series VSAs.

With 1.28 Mcps functionality this analysis package handles the TSM version of TD-SCDMA. Single code domain layer or composite power and code domain displays are provided. Normalize code-domain power to display code domain power relative to total signal power. Automatic measurements include rho, EVM, frequency error, I/Q offset and I/Q skew.

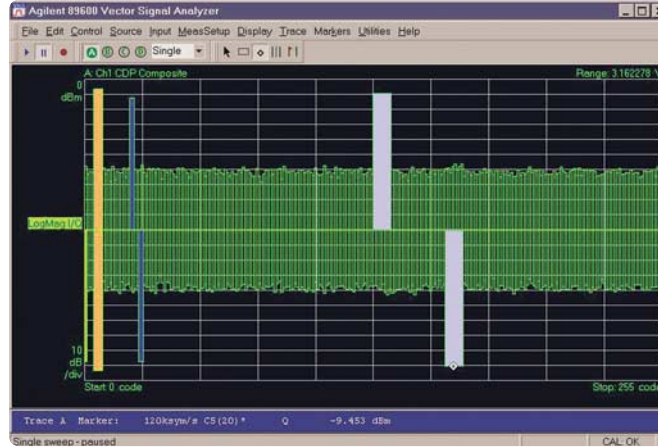

View the CDP of a W-CDMA uplink signal. The signal has been separated into I and Q branches. The I channels appear on the top half of the trace; Q channels appear inverted on the bottom half of the trace.

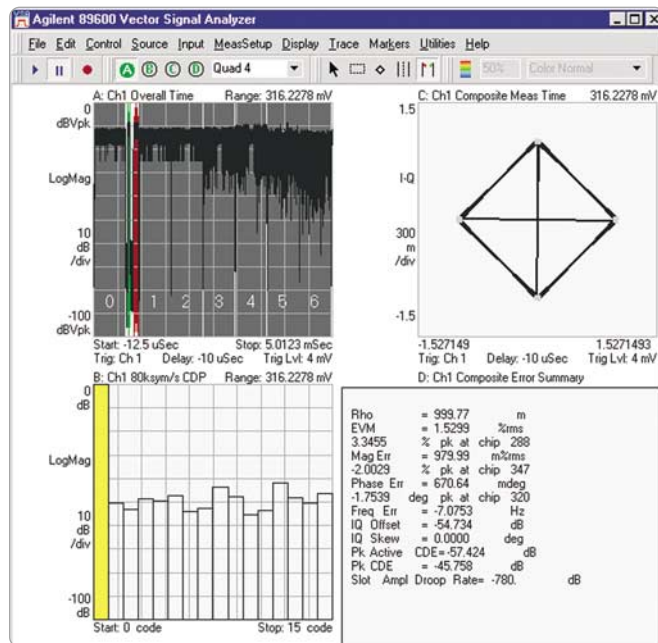

Measure TD-SCDMA signals with the 89600. The analyzer is showing the constellation, code domain power, overall time slot usage, and nine parametric measures all on one display.

1xEV-DO

Measure and analyze 1xEV-DO modulated signals with the capabilities offered as part of Option B7N, 3G modulation analysis. Descramble, despread, and demodulate 1xEV-DO modulated signals. You can also analyze the reverse link (mobile station or access terminal) and forward link (base station or access network) channels. The analyzer automatically identifies all active channels regardless of the symbol rate or Walsh code length.

The advanced technology demodulator used in this option does not require coherent carrier signals, or symbol-clock timing signals, and comes with an internal IS-2000 filter. All you have to do is enter carrier frequency, chip rate, reverse/forward link direction, and set the long code mask. The analyzer will do the rest.

Measurement results include CDP (composite or layer specific), code domain error (composite or layer specific), EVM, IQ offset, rho, overall 1 rho, and overall 2 rho.

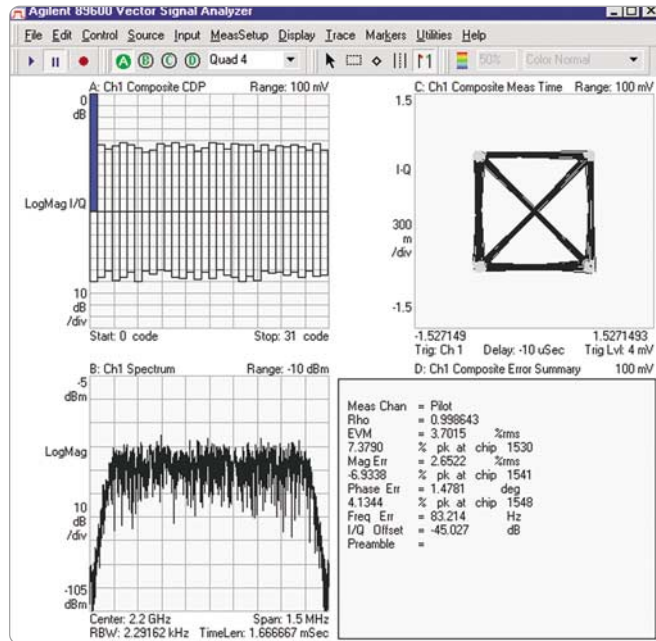

Measure CDP, code domain error, EVM, rho and more with 1xEV-DO modulation analysis provided in Option B7N.

Market Leading WLAN Analysis (Option B7R)

WLAN analysis capabilities

Agilent is an industry leader in baseband, RF, and modulation quality measurements of WLAN signals. The 89600 VSA's WLAN analysis option offers

- 802.11a OFDM modulation analysis
- 802.11b DSSS/CCK/PBCC modulation analysis
- 802.11g modulation analysis
- 802.11a/b/g standards-based testing

Two modes, DSSS/CCK/PBCC and OFDM, are offered with Option B7R WLAN analysis. Use these modes together to analyze 802.11g modulation; use them separately to analyze 802.11b or 802.11a signals.

802.11b modulation analysis

Select the DSSS/CCK/PBCC mode and automatically detect, despread, descramble, and demodulate the payload in all four mandatory 802.11b formats (1, 2, 5.5, 11 Mbps). This mode handles the optional PBCC modes, the optional short preamble, and the CCK preamble of the CCK-OFDM format in 802.11g. Examine the constellation diagram, measure EVM, frequency error, quadrature error, gain imbalance, and more with the 89600 Series WLAN analysis option.

Use the time domain measurement capability provided with the 89600 VSA to evaluate your signal's power versus time behavior. Use the gate time feature to analyze the spectrum of just a portion of the burst. All of these and more are available with the DSSS/CCK/PBCC mode for 802.11b analysis.

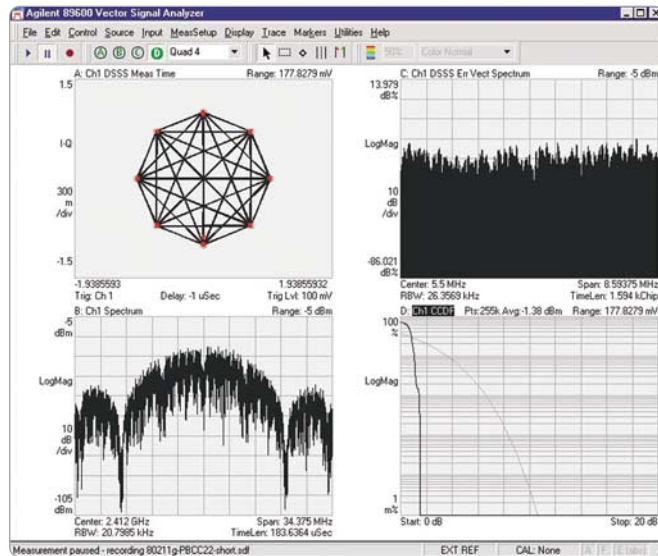

Demodulate the optional PBCC modes of 802.11g

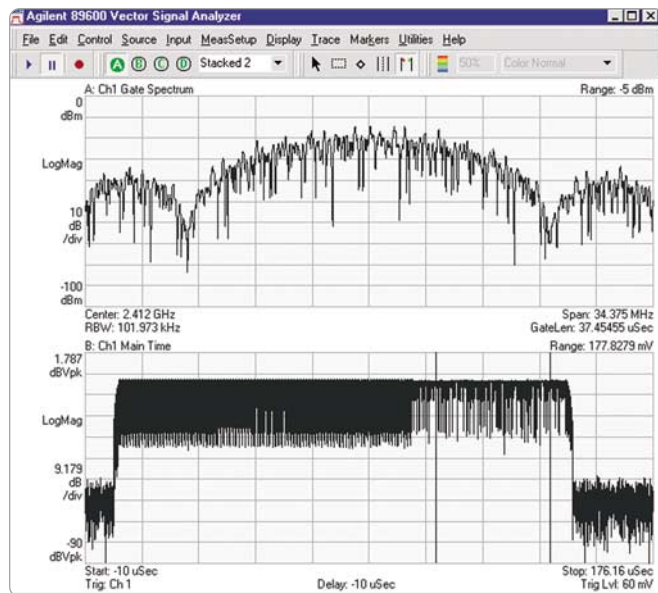

Time gating is a powerful tool for selective analysis of time waveforms. The time gate (two vertical lines in the lower trace) allows FRT analysis on only the payload portion of the waveform.

802.11a modulation analysis

Demodulate and analyze 802.11a, 802.11g, and HiperLAN2 compatible signals with the OFDM modulation analysis mode provided in Option B7R. This high performance capability supports demodulating OFDM bursts down to the bit level. Use the compound constellation display to automatically determine and display all modulation formats (BPSK, QPSK, 16QAM, 64QAM) present in the burst. Evaluate modulation quality using EVM displays of the overall burst, of each symbol, or of each sub-carrier in a symbol. View all of this data in an efficient graphical display that reveals overall patterns in the EVM – a key to finding the root cause of signaling problems. View the average phase and magnitude behavior of the pilot subcarriers using the Common Pilot Error display. Measure the magnitude and phase settling of the OFDM burst using the preamble error-testing tool. These features and more, combined with the analysis tools already offered in the 89600 VSAs provide you a powerful package for analyzing and troubleshooting OFDM signals.

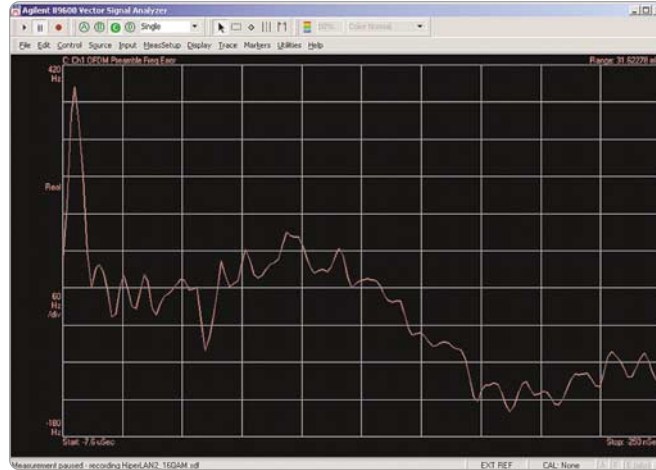

Examine the frequency settling of your 802.11a burst with the powerful preamble error display in Option B7R.

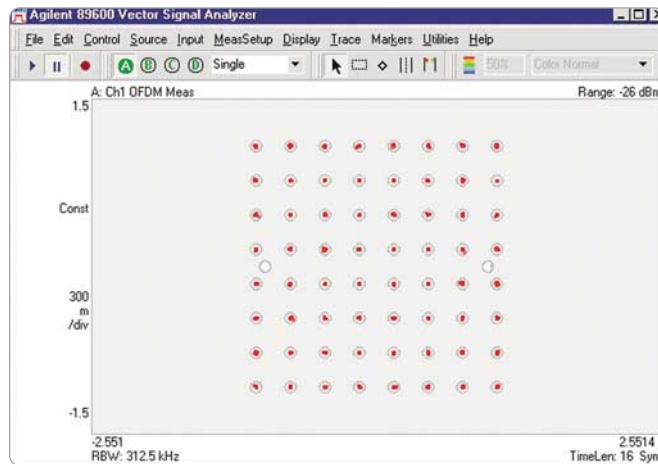

View the constellations of all modulation formats in an 802.11a OFDM burst. The 89600 has automatically determined the modulated format, selected the BPSK and 64QAM demodulators, and set up a compound constellation display.

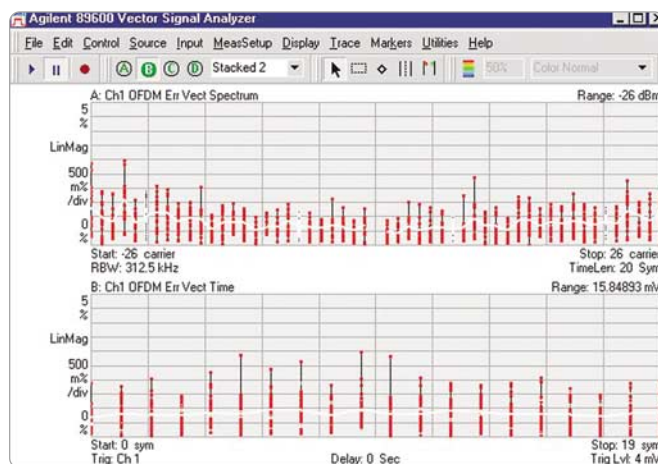

View the EVM of an 802.11a OFDM burst by sub-carrier (upper trace) or symbol (lower trace)

802.11a/b/g test suite

Speed the process of testing your 802.11a/b/g signal to its standard with the 802.11 test suite (supplied as part of the WLAN analysis Option B7R). This separate applet automatically executes standards-based transmitter tests of your signal. You specify the tests to perform, set the center frequency and other signal parameters, and the applet does the rest.

The tests provided in WLAN test suite include: transmit power, center frequency and symbol clock frequency tolerance, modulation accuracy, and spectral mask. Standards-based test limits are pre-programmed into the software, but can be modified as your need requires. You can even change the profile of the limit lines. Results are available as pass/fail or measured data, and are available to download to a spreadsheet, report, or a network.

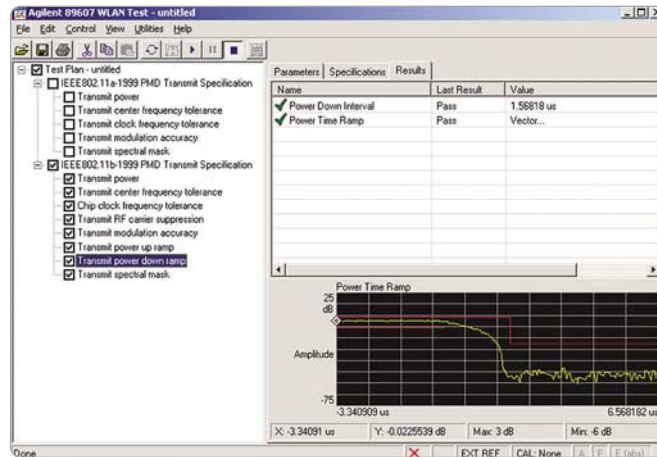

One-button, standards-based measurements of your 802.11 signal quickly help you determine if the signal has any problems.

Unique Error Analysis Tools Highlight Problems

Agilent 89600 VSAs offer sophisticated error analysis that lets you see both RF and DSP problems. The key is the EVM measurement. The EVM time-plots an error signal versus time diagram. With it, you can identify problems such as clock timing errors, DAC overflow, compensation errors and more – all with one screen. These tools include EVM time, EVM spectrum, and adaptive equalization.

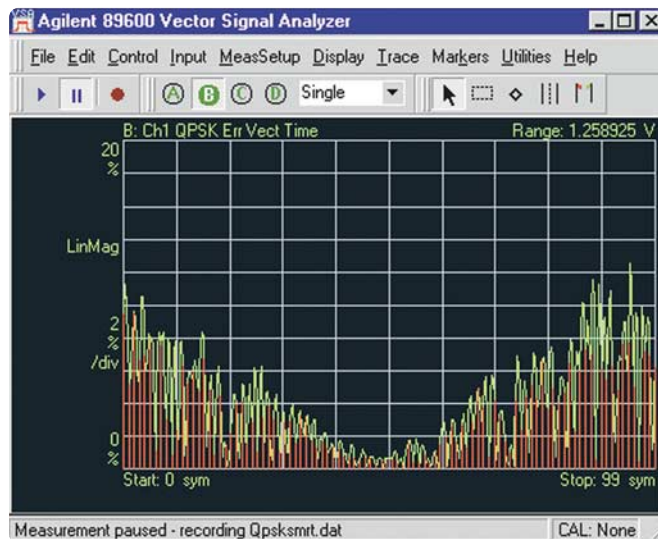

The 'v' shape in the EVM versus time display indicates a symbol clock timing error. Trace math can help determine the approximate clock rate.

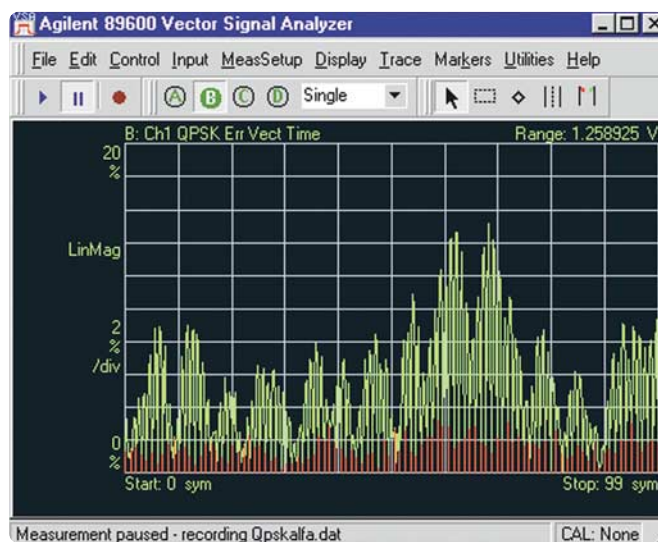

This signal shows higher EVM in between the symbols (shown in green) than at the symbol clock times (shown in red), a clear indication of filtering errors. Next, you can try and determine the correction needed by using the adaptive equalization feature.

Error vector magnitude (EVM)

EVM is a powerful analysis tool that helps you pinpoint marginal conditions before they become system performance problems. EVM compares the phase and magnitude of the input signal with an ideal reference signal stream. The average error over time is displayed as a single percent, or the error can be viewed on a symbol by symbol basis.

Use the FFT of the EVM error signal to identify systematic impairments you couldn't otherwise see. Identify spurs coupling from other parts of the system by looking at the EVM spectrum for peaks.

Adaptive equalization

Adaptive equalization identifies and removes linear errors from I-Q modulated signals by dynamically creating and applying a compensating filter. These errors include group delay distortion, frequency response errors, and reflections or multipath distortion. You can also uncover DSP errors such as miscoded bits, or incorrect filter coefficients.

Equalization is a tool designers can use to identify and correct linear errors. Pre-distorting a signal to correct for linear errors can be simpler, faster, and cheaper than modifying hardware to make the corrections. Further, some wideband signals are almost impossible to measure without adaptive equalization.

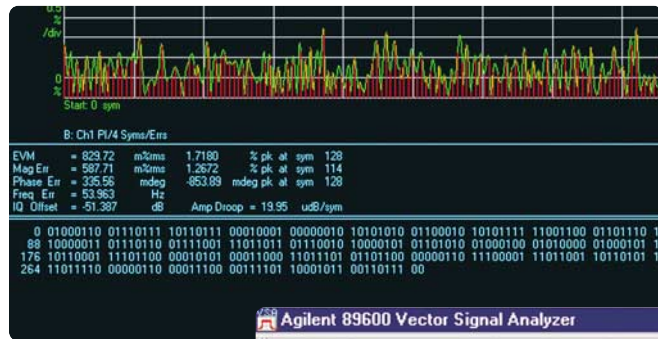

EVM versus time and the symbol table

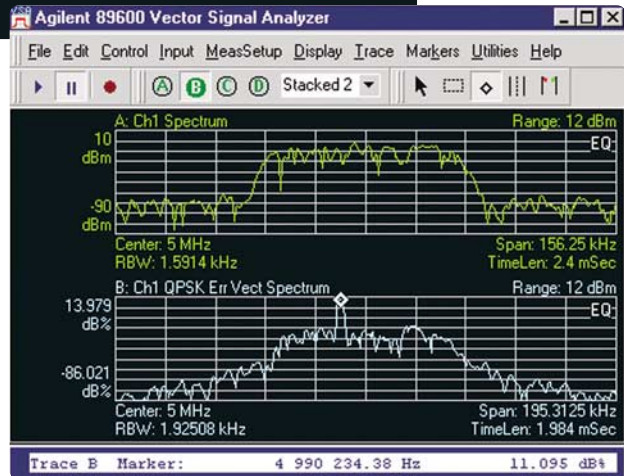

The FFT of the EVM error signal shows a contaminating signal from an earlier stage's phase lock loop (PLL). Such an error would be impossible to see on a spectrum analyzer because it is riding under the modulation envelope.

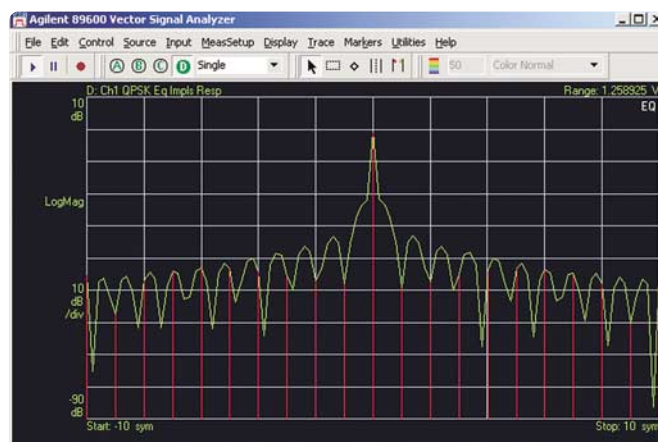

Equalization filter impulse response coefficients can be downloaded to digitally correct an incoming signal with linear distortions. Here the equalizer corrected the signal for a missing Nyquist filter.

Advanced Measurement Displays

Display your results in constellation, eye, trellis, or spectrum diagrams. Detect intersymbol interference, quadrature balance and error, and spurious responses. Measure carrier peaks and state transitions in both time and amplitude. In addition to these common displays, you can also take advantage of the powerful spectrogram display. Its three-dimensional view lets you see the behavior of your signal over time with magnitude shown in color or grayscale.

Complementary cumulative distribution function (CCDF)

Since digital signals are noise-like, statistical measurements provide a better description of system or component behavior. The power statistics of the signal can be characterized by performing several peak-to-average measurements and displaying the results in a graph known as the CCDF. The CCDF curve shows the probability that the power is equal to or above a certain peak to average ratio. The higher the peak-to-average power ratio, the lower the probability of reaching it.

View signal instabilities with analog demodulation error analysis

The 89600 VSAs feature AM, PM, and FM demodulation as standard tools. Use each of these to evaluate signal amplitude, phase, or frequency deviations. Calculating the FFT of these deviations often provides insight into signals coupling through from other parts of the circuit.

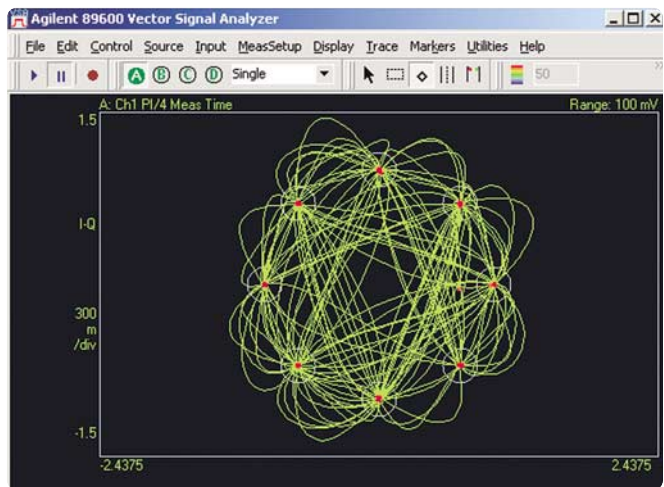

$\pi/4$ DQPSK IQ diagram

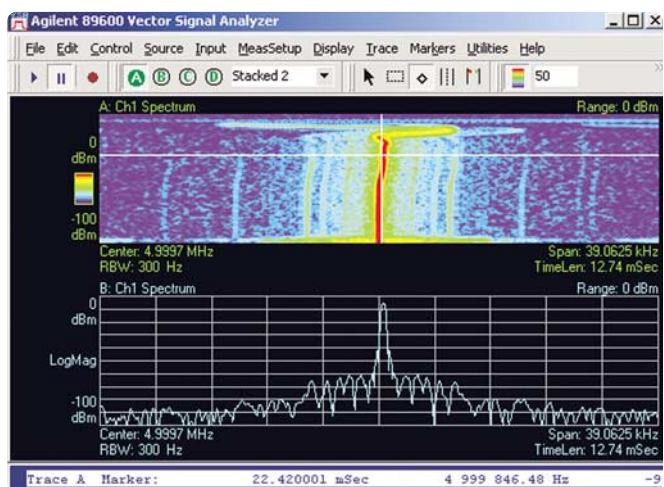

A spectrogram is a three-dimensional representation of a radio's signal over time at the antenna, where color represents magnitude. In this case the spectrogram shows a signal's frequency deviation over time.

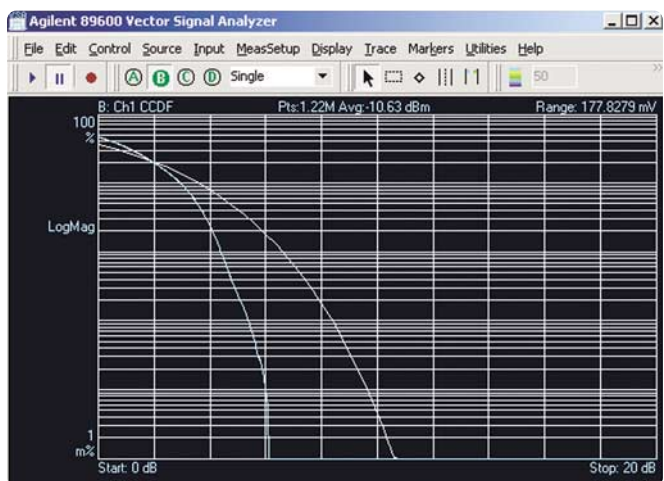

CCDF curve of 16QAM signal

Easy-to-Use Windows Graphical User Interface

Changing parameters such as center frequency, span, or scale, is easy. Simply place the cursor on the parameter and a hand will appear. Double click and enter the parameter or use the up/down arrows. If you are familiar with Microsoft Windows applications, you can quickly master the 89600 VSA.

Markers and band power measurements

To identify signals using the marker function, simply place a marker on the highest signal using the marker search functions. The marker parameters are shown at the bottom of the display. Use the offset marker to measure parameters between two points on the display.

Signal zoom

For a closer look at a signal, use the highlight box to zoom in. Place the box around the signal of interest and select the desired scaling. You can scale both the X- and Y-axis, or scale each separately.

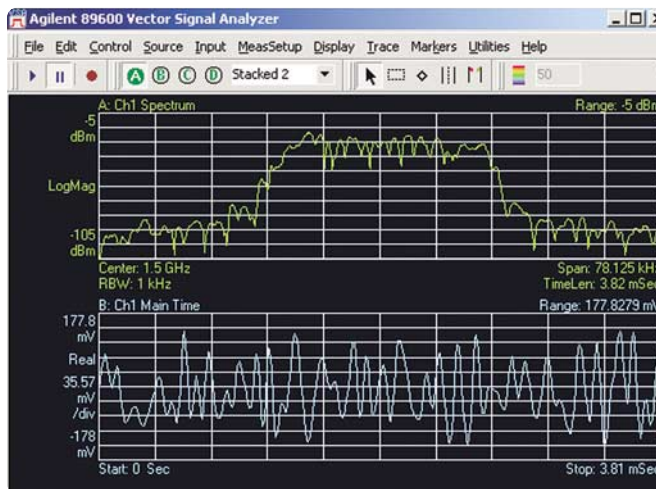

The top display is the frequency domain view and the bottom is the time domain view of a modulated signal.

Share this Software Among Many Users

Get the most from your 89600 VSA investment. Share the 89600 VSA's signal analysis software among all your users, without moving any hardware.

The network share version of the 89600 software (89601AN) puts the "license-to-use" on your network rather than in a PC. This network share product comes with a copy of the software that can be loaded on as many PC's as you like. To use the software you simply get the license from your network server. When you're done with it return the license to the server for the next person to use.

The network shared 89600 VSA software works well with, and without, hardware. Use it with our 89600 VXI hardware, Agilent's ADS design software, spectrum analyzers and Infiniium oscilloscopes or stand-alone to analyze signal capture files. Whatever you choose to use it with, the 89601AN network shared VSA software will maximize the return on your software investment.

Uncover System Problems Even Before Hardware Exists

The powerful, PC-based 89600 Series VSA software enables tight, interactive integration with ADS to analyze computational data. The 89600 software can be dynamically linked to any point in the digital model to analyze data by simply dragging the VSA icon to the desired spot in the schematic.

Since the VSA measurement software resides on a PC, it performs equally well analyzing measured data from the VXI mainframe or computational data produced by an ADS model.

You can record measured or computed data from ADS with the 89600 Series software and play it back for further analysis. The playback can be continuously looped at reduced speeds for more in depth review. Individual recorded signals can be analyzed more closely by zooming in using the span and center frequency adjustments.

Link real-world signals recorded with the 89600 to the ADS to provide an actual signal environment for your design stimulus.

With the new instrument links from ADS to the Agilent ESG signal generators, you can take simulation output, download it to the ESG, and source it to your prototype hardware. The hardware can be measured with the 89600 VSA, and compared to the simulation if desired. Conversely, you can measure the output of prototype hardware with the 89600 VSA, and use it to stimulate a simulation. In this way you can evaluate your system even with missing hardware.

Use "virtual hardware" to make measurements and evaluate your system even when hardware is missing.

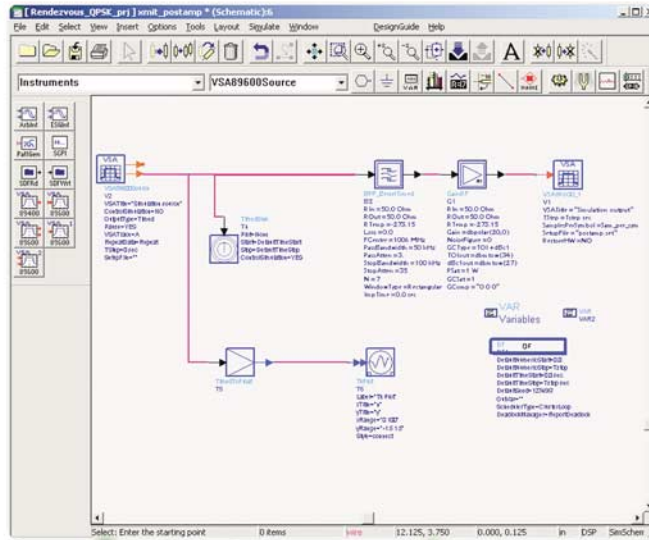

Measurements from actual prototype hardware can be fed into a design simulation.

Take a simulation output file and download it to the Agilent ESG signal generator to stimulate your device under test.



DUT

Use the Agilent 89600 to make measurements on your device. You can also compare it to measurements you made on the simulated DUT.



Add World-class Modulation Analysis to Agilent Spectrum Analyzers, Oscilloscopes, and More.

Link the 89600 software to variety of Agilent instruments to enhance their modulation evaluation and troubleshooting capabilities. The software runs on a PC and connects to an Agilent instrument via GPIB or LAN. To order the 89600 software separate from its VXI measurement hardware, order model number 89601A vector signal analysis software.

Team the 89600 software with Agilent's ESA-E Series spectrum analyzers. This combination adds the flexible digital demodulation and analysis capabilities of the 89600 software to the frequency coverage and general-purpose spectrum analysis capabilities of the ESA spectrum analyzers.

Hook the 89600 software to any Agilent PSA high-performance spectrum analyzer. All of the features of the PSA Series: high-performance spectrum analysis, one-button advanced power measurements, and standards-based digital modulation analysis, are combined with the flexible demodulation and analysis capabilities of the 89600 software. This powerful combination provides a comprehensive solution to almost any communications system problem.

Combine the software with Agilent's Infiniium oscilloscopes (some models) to analyze super wide bandwidth signals. The oscilloscopes provide up to 6 GHz of analysis bandwidth and are well suited to digitizing down-converted satellite, LMDS, and MMDS signals. The digitized signals are transferred via GPIB or LAN to the PC running the 89600 software where the frequency, time, and modulation analysis tools of the 89600 can be used to evaluate and troubleshoot the signal.

Connect Agilent's E4406A VSA transmitter tester with the 89600 software and you have two high-performance instruments: a superior multi-format standards based transmitter tester and a high-performance flexible digital demodulation and analysis tool.



Ordering Information

89600 Series vector signal analyzers

89610	dc to 40 MHz
89611	70 MHz IF
89640	dc to 2700 MHz
89641	dc to 6000 MHz

Options

The following capabilities are available as options:

- vector modulation analysis
- 3G modulation analysis
- WLAN modulation analysis
- signal capture memory for each input channel (144 MB, 288 MB, 1152 MB)
- one additional baseband channel (89610 only)
- one additional IF/baseband channel (89611, 89640, 89641)
- one additional RF channel (89640, 89641)
- connectivity to Advanced Design System (ADS) software

Minimum PC requirement: see the Agilent 89600 Series Configuration Guide, available on the web at: www.agilent.com/find/89600

For more information, specifications, or literature on the 89600 Series VSAs, please visit:

www.agilent.com/find/89600

Agilent Technologies' Test and Measurement Support, Services, and Assistance

Agilent Technologies aims to maximize the value you receive, while minimizing your risk and problems. We strive to ensure that you get the test and measurement capabilities you paid for and obtain the support you need. Our extensive support resources and services can help you choose the right Agilent products for your applications and apply them successfully. Every instrument and system we sell has a global warranty. Support is available for at least five years beyond the production life of the product. Two concepts underlie Agilent's overall support policy: "Our Promise" and "Your Advantage."

Our Promise

Our Promise means your Agilent test and measurement equipment will meet its advertised performance and functionality. When you are choosing new equipment, we will help you with product information, including realistic performance specifications and practical recommendations from experienced test engineers. When you use Agilent equipment, we can verify that it works properly, help with product operation, and provide basic measurement assistance for the use of specified capabilities, at no extra cost upon request. Many self-help tools are available.

Your Advantage

Your Advantage means that Agilent offers a wide range of additional expert test and measurement services, which you can purchase according to your unique technical and business needs. Solve problems efficiently and gain a competitive edge by contracting with us for calibration, extra-cost upgrades, out-of-warranty repairs, and onsite education and training, as well as design, system integration, project management, and other professional engineering services. Experienced Agilent engineers and technicians worldwide can help you maximize your productivity, optimize the return on investment of your Agilent instruments and systems, and obtain dependable measurement accuracy for the life of those products.



Agilent Email Updates

www.agilent.com/find/emailupdates

Get the latest information on the products and applications you select.

Agilent T&M Software and Connectivity

Agilent's Test and Measurement software and connectivity products, solutions and developer network allows you to take time out of connecting your instruments to your computer with tools based on PC standards, so you can focus on your tasks, not on your connections. Visit www.agilent.com/find/connectivity for more information.

By internet, phone, or fax, get assistance with all your test & measurement needs

Phone or Fax

United States:
(tel) 800 452 4844

Canada:
(tel) 877 894 4414
(fax) 905 282 6495

China:
(tel) 800 810 0189
(fax) 800 820 2816

Europe:
(tel) (31 20) 547 2323
(fax) (31 20) 547 2390

Japan:
(tel) (81) 426 56 7832
(fax) (81) 426 56 7840

Korea:
(tel) (82 2) 2004 5004
(fax) (82 2) 2004 5115

Latin America:
(tel) (305) 269 7500
(fax) (305) 269 7599

Taiwan:
(tel) 0800 047 866
(fax) 0800 286 331

Other Asia Pacific Countries:
(tel) (65) 6375 8100
(fax) (65) 6836 0252
Email: tm_asia@agilent.com

Online Assistance:
www.agilent.com/find/assist

Product specifications and descriptions in this document subject to change without notice.

**© Agilent Technologies, Inc. 2002, 2003
Printed in U.S.A., July 21, 2003
5980-0723E**

Microsoft, Windows, and Windows NT are U.S. registered trademarks of Microsoft Corporation.

MATLAB® is a U.S. registered trademark of The Math Works, Inc.

cdma2000® is a registered trademark of the Telecommunications Industry Association (TIA-USA).



Agilent Technologies